

ISA/ISPA-W

Super Large Single-Axis Robot

ISDACR/ISPDACR-W

Super Large Single-Axis Robot Cleanroom Type



The Results of Our Quest for Ultimate Performance

ISA/ISPA/ISDACR/ISPDACR

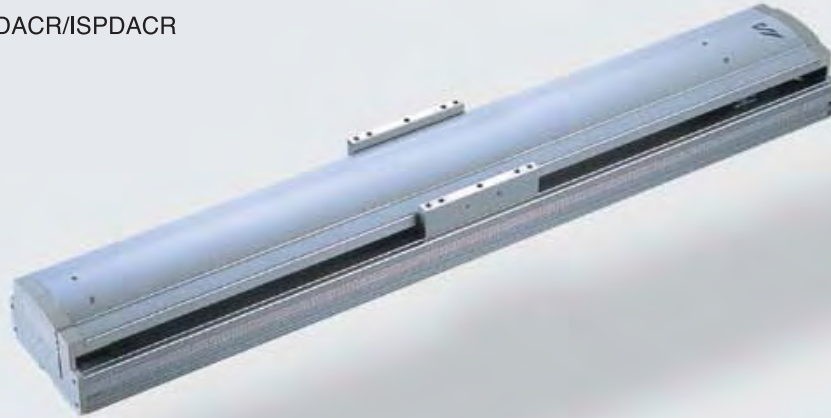

Super large type actuator capable of transferring up to 150 kg

ISA/ISPA



Long-stroke cleanroom type conforming to cleanliness class 10

ISDACR/ISPDACR

(*) The ISPA and ISPDACR are high-precision versions of the ISA and ISDACR

Sold & Serviced By:

 **ELECTROMATE**

Toll Free Phone (877) SERV098

Toll Free Fax (877) SERV099

www.electromate.com

sales@electromate.com

Super Large Single-Axis Robot (Standard/ Cleanroom Types) Capable of Transferring Loads Weighing up to 150 kg for a Maximum Distance of 2500 mm

1. Long Stroke / Cleanliness Class 10

By integrating the mid-support mechanism, a long stroke of up to 2500 mm was achieved. The ball screw that runs the slider enables high-accuracy and transfer of heavy loads. The cleanroom type adopting a stainless-sheet seal structure conforms to cleanliness class 10. High-speed transfer over long distance has now become possible inside a cleanroom.

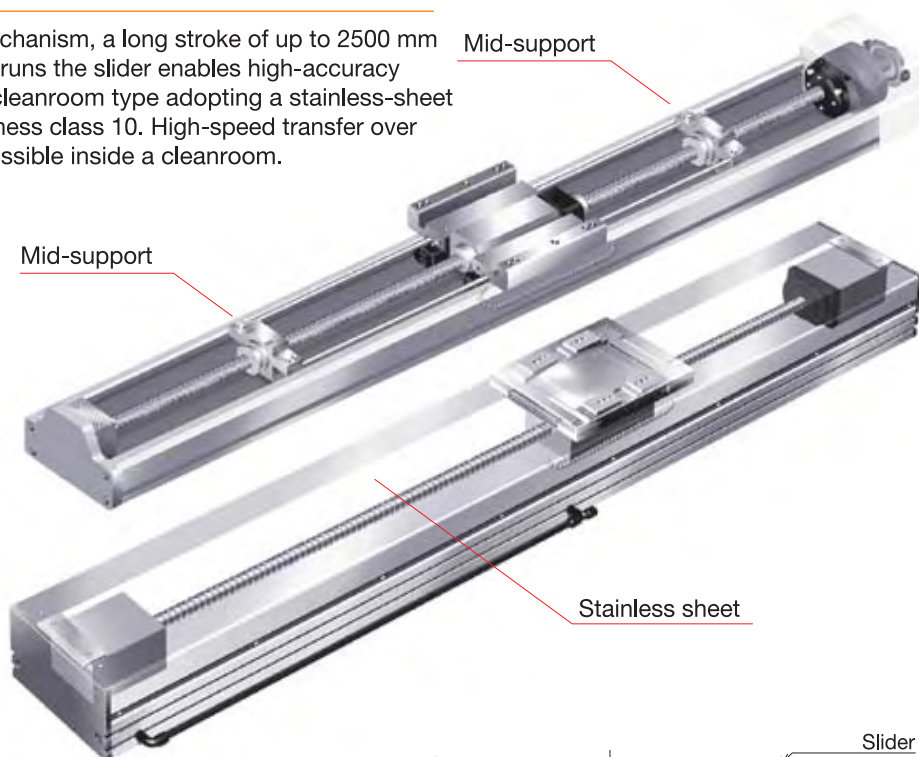

2. High Load Capacity

The high-output motor and high-rigidity base integrate to achieve a maximum load capacity of 150 kg in horizontal applications and 60 kg in vertical applications.

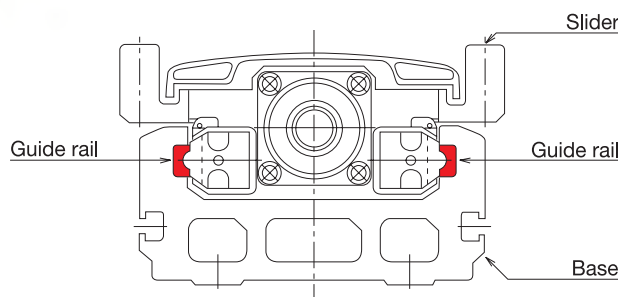

Cross section view of ISA series

3. High Speed and Quick Acceleration

The maximum speed of 2400 mm/sec and maximum acceleration/deceleration of 1 G help shorten the cycle time considerably.

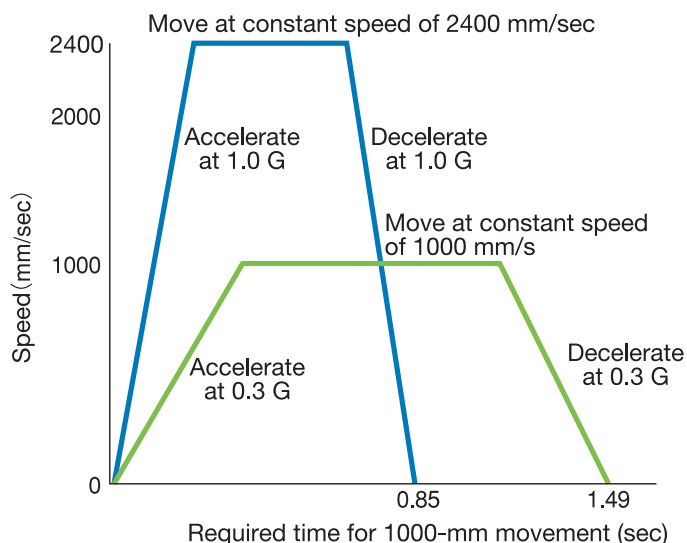

4. High Precision

The ISPA/ISPDACR adopts a C5-equivalent precision rolled screw to achieve a positioning repeatability of ± 0.01 mm.

5. Adjustable Cable Outlet Direction (ISA Series)

With the ISA Series, the cable outlet direction can be changed from the rear (standard) to side (left or right), providing a space-saving solution in the longitudinal direction.

Model Specification Items

Select the applicable codes and values for items **1** through **9** below to specify the model.
Refer to the facing page for the details of each item.

		1	2	3	4	5	6	7	8	9						
		Series	Type	Encoder type	Motor output	Lead	Stroke	Applicable controller	Cable length	Options						
1	Single-Axis Robot: Super Large Type	ISA ISPA	WXM	-	-	40 20 10	100 ~ 1300	-	-	-						
						600	50 25									
2	Single-Axis Robot: Super Large Mid-Support Type		WXXM			-	-				600	40 20	900 ~ 2500	-	-	N S M X□□
											750	50 25				
3	Single-Axis Robot: Super Large Cleanroom Type	ISDACR ISPDACR	W	-	-	600	40 20 10	100 ~ 1300	T1 T2	-	-					
						750	50 25									
4	Single-Axis Robot: Super Large Cleanroom Mid-Support Type		WX			-	-	600				40 20	900 ~ 2500	-	-	-
								750				50 25				

Specification Table

Type	Stroke (mm) and maximum speed (mm/sec)																			Motor output (W)	Lead (mm)	Maximum speed (mm/sec)		
	100 ~ 700	800	900	1000	1100	1200	1300	1400	1500	1600	1700	1800	1900	2000	2100	2200	2300	2400	2500					
ISA-WXM ISPA-WXM	2400		1840	1530	1290	1100	950														600	40	2000	
	1200		920	765	645	550	475															20	1000	
	600		460	380	320	270	235															10	500	
	2000				1840	1570	1360														750	50	2000	
	1250			1090	920	785	680															25	1250	
ISA-WXXM ISPA-WXXM	2400					2200	1965	1725	1530	1365	1225	1110	1005	915	840	770	710	655			600	40	2000	
	1200					1100	980	860	765	680	610	555	500	455	420	385	355	325				20	1000	
	2000											1930	1740	1580	1440	1320	1210	1115	1035			750	50	2000
	1250								1200	1075	965	870	790	720	660	605	555	515			25		1250	
ISDACR -W ISPDACR -W	2000	1965	1605	1335	1130	970	840														600	40	2000	
	1000	980	800	665	565	485	420															20	1000	
	500	490	400	330	280	240	210															10	500	
	2000				1780	1525	1320														750	50	2000	
	1250			1050	890	760	660															25	1250	
ISDACR -WX ISPDACR -WX	2000					1965	1725	1530	1365	1225	1110	1005	915	840	770	710	655			600	40	2000		
	1000					980	860	765	680	610	555	500	455	420	385	355	325				20	1000		
	2000											1930	1740	1580	1440	1320	1210	1115	1035			750	50	2000
	1250								1200	1075	965	870	790	720	660	605	555	515			25		1250	

3

1 Series

Indicates the name of each series.

ISA: Single-axis robot, standard specification
 ISPA: Single-axis robot, high-precision specification
 ISDACR: Cleanroom type single-axis robot, standard specification
 ISPDACR: Cleanroom type single-axis robot, high-precision specification

2 Type

Indicates the classification by shape (e.g., slider, arm), size (e.g., S, M, L), etc.

WXM: Super large X-axis type
 WXMx: Super large mid-support X-axis type
 W: Super large type
 WX: Super large mid-support type

3 Encoder type

Indicates whether the encoder installed in the actuator is the "absolute type" or "incremental type."

A: Absolute type
 The current slider position will be retained even after the power is turned off, so home return is not required the next time the power is turned on.
 I: Incremental type
 The slider position data will be cleared once the power is turned off, so home return is required every time the power is turned on.

4 Motor output

Indicates the output of the motor installed in the actuator (unit: W).

5 Lead

Indicates the ball screw lead.
 The lead refers to the distance the slider travels with each revolution of the ball screw (unit: mm).
 The greater the lead is, the faster the maximum speed becomes.

6 Stroke

Indicates the actuator stroke (operating range) (unit: mm).

7 Applicable controller

Indicates the types of supported controllers.
 T1: X-SEL-J/K, SCON, SSEL
 T2: X-SEL-P/Q

8 Cable length

Indicates the length of the motor/encoder cables that connect the actuator and the controller.
 N: No cable
 S: 3 m
 M: 5 m
 X□□: Specify a length other than 3 and 5 m. (Example: X08 = 8 m)
 * The standard motor / encoder cables are robot cables.

9 Options

Indicates the options to be equipped on the actuator.
 Refer to page 13 for the details of each option.
 * When selecting multiple options, enter the desired options in alphabetical order. (Example: AQ-B-L-NM)

Model	Rated acceleration (G)	Load capacity at rated acceleration (kg)		Maximum acceleration (G)	Load capacity by acceleration (kg)							
					0.3G	0.4G	0.5G	0.6G	0.7G	0.8G	0.9G	1.0G
IS(P)A-WXM- □-600-40-□□□	0.3	Horizontal	60	1.0	60	45	36	30	26	22	20	18
	0.3	Vertical	14	1.0	14	12	10	8	6.7	6.1	5.6	5
IS(P)A-WXM- □-600-20-□□□	0.3	Horizontal	120	1.0	120	91	72	60	52	45	40	36
	0.3	Vertical	29	0.8	29	26	23	20	17.5	15	—	—
IS(P)A-WXM- □-600-10-□□□	0.3	Horizontal	150	0.6	150	112	90	75	—	—	—	—
	0.3	Vertical	60	0.5	60	50	40	—	—	—	—	—
IS(P)A-WXM- □-750-50-□□□	0.3	Horizontal	60	1.0	60	45	36	30	25	22	20	18
	0.3	Vertical	14	1.0	14	12	10	8	6.7	6.1	5.6	5
IS(P)A-WXM- □-750-25-□□□	0.3	Horizontal	120	1.0	120	91	72	60	52	45	40	36
	0.3	Vertical	29	0.8	29	26	23	20	17.5	15	—	—
IS(P)A-WXMX- □-600-40-□□□	0.3	Horizontal	60	0.3	60	—	—	—	—	—	—	—
			120		120	—	—	—	—	—	—	
IS(P)A-WXMX- □-600-20-□□□	0.3	Horizontal	60	0.3	60	—	—	—	—	—	—	—
			120		120	—	—	—	—	—	—	
IS(P)A-WXMX- □-750-50-□□□	0.3	Horizontal	60	0.3	60	—	—	—	—	—	—	—
			120		120	—	—	—	—	—	—	
IS(P)A-WXMX- □-750-25-□□□	0.3	Horizontal	60	0.3	60	—	—	—	—	—	—	—
			120		120	—	—	—	—	—	—	
IS(P)DACR-W- □-600-40-□□□	0.3	Horizontal	60	1.0	60	45	36	30	26	22	20	18
	0.3	Vertical	14	1.0	14	12	10	8	6.7	6.1	5.6	5
IS(P)DACR-W- □-600-20-□□□	0.3	Horizontal	120	1.0	120	91	72	60	52	45	40	36
	0.3	Vertical	29	0.8	29	26	23	20	17.5	15	—	—
IS(P)DACR-W- □-600-10-□□□	0.3	Horizontal	150	0.6	150	112	90	75	—	—	—	—
	0.3	Vertical	60	0.5	60	50	40	—	—	—	—	—
IS(P)DACR-W- □-750-50-□□□	0.3	Horizontal	60	1.0	60	45	36	30	25	22	20	18
	0.3	Vertical	14	1.0	14	12	10	8	6.7	6.1	5.6	5
IS(P)DACR-W- □-750-25-□□□	0.3	Horizontal	120	1.0	120	91	72	60	52	45	40	36
	0.3	Vertical	29	0.8	29	26	23	20	17.5	15	—	—
IS(P)DACR-WX- □-600-40-□□□	0.3	Horizontal	60	0.3	60	—	—	—	—	—	—	—
			120		120	—	—	—	—	—	—	
IS(P)DACR-WX- □-600-20-□□□	0.3	Horizontal	60	0.3	60	—	—	—	—	—	—	—
			120		120	—	—	—	—	—	—	
IS(P)DACR-WX- □-750-50-□□□	0.3	Horizontal	60	0.3	60	—	—	—	—	—	—	—
			120		120	—	—	—	—	—	—	
IS(P)DACR-WX- □-750-25-□□□	0.3	Horizontal	60	0.3	60	—	—	—	—	—	—	—
			120		120	—	—	—	—	—	—	

ISA-WXM-600

Single-Axis Robot: Super Large X-Axis Long Slider Type, Actuator Width 198mm, 600W, Straight Shape

ISPA-WXM-600

Single-Axis Robot: Super Large X-Axis Long Slider Type, Actuator Width 198mm, 600W, Straight Shape, High-Precision Specification

Type	Super large X-axis (198-mm wide) Long slider type	Stroke	100~1300mm	Load capacity	150kg (horizontal)/60kg (vertical)
------	---	--------	------------	---------------	------------------------------------



Model specification items Series Type Encoder type Motor output Lead Stroke Applicable controller Cable length Options

(Example) ISA -WXM - I - 600 - 40 -1300 - T1 - S -C-L

* Refer to page 3 for the details of model specification items.

Models/Specifications

Model	Encoder Type	Motor output (W)	Lead (mm)	Stroke 100mm increments (mm)	Speed (Note 1) (mm/s)	Acceleration (Note 2)				Load capacity (Note 2)				Rated thrust (N)
						Horizontal (G)		Vertical (G)		Horizontal (kg)		Vertical (kg)		
						Rated	Maximum	Rated	Maximum	Rated	Maximum	Rated	Maximum	
ISA [ISA]-WXM-[1]-600-40-[2]-[3]-[4]-L-[5]	Absolute	600	40	100 ~ 1300	1 ~ 2400	0.3	1.0	0.3	1.0	60	18	14	5	255
ISA [ISPA]-WXM-[1]-600-20-[2]-[3]-[4]-L-[5]			20		1 ~ 1200	0.3	1.0	0.3	0.8	120	36	29	15	510
ISA [ISPA]-WXM-[1]-600-10-[2]-[3]-[4]-L-[5]			10		1 ~ 600	0.3	0.6	0.3	0.5	150	75	60	40	1020

* In the above model names, [1] indicates the encoder type, [2] the stroke, [3] the applicable controller, [4] the cable length, and [5] the applicable options.

Options

Name	Code	Page	Name	Code	Page
AQ seal	AQ	P13	Master-axis designation	LM	P13
Brake	B	P13	Reversed home specification	NM	P13
Creep sensor	C	P13	Slave-axis designation	S	P13
Home limit switch	L	P13	Cable Exit Direction	A1/A3	Diagram Below

* The WXM type comes standard with home limit switch (code: L).

Common Specifications

* The specifications of the ISPA are shown in [].

Positioning repeatability (Note 3)	±0.02mm [±0.01mm]
Drive system (Note 4)	Ball screw ø20mm, equivalent to rolled C10 [equivalent to C5]
Backlash (Note 5)	0.05mm or less [0.02mm or less]
Guide	Integrated with base
Allowable load moment (Note 6)	Ma: 139.2N • m, Mb: 199.9N • m, Mc: 391N • m
Overhang load length	Ma/Mb/Mc directions: 900mm or less
Base	Material: Aluminum with white alumite treatment
Applicable controller	T1: XSEL-J/K, T2: XSEL-P/Q, SSEL, SCON
Cable length (Note 7)	N: No cable, S: 3m, M: 5m, X□□: Length specification
Ambient operating temperature/humidity	0~40°C, 85% RH (non-condensing)

Dimensions

* Those equipped with an optional brake have the same external dimensions, but the weight increases by 0.5 kg.

* To change the home direction, the actuator must be returned to IAI for adjustment.

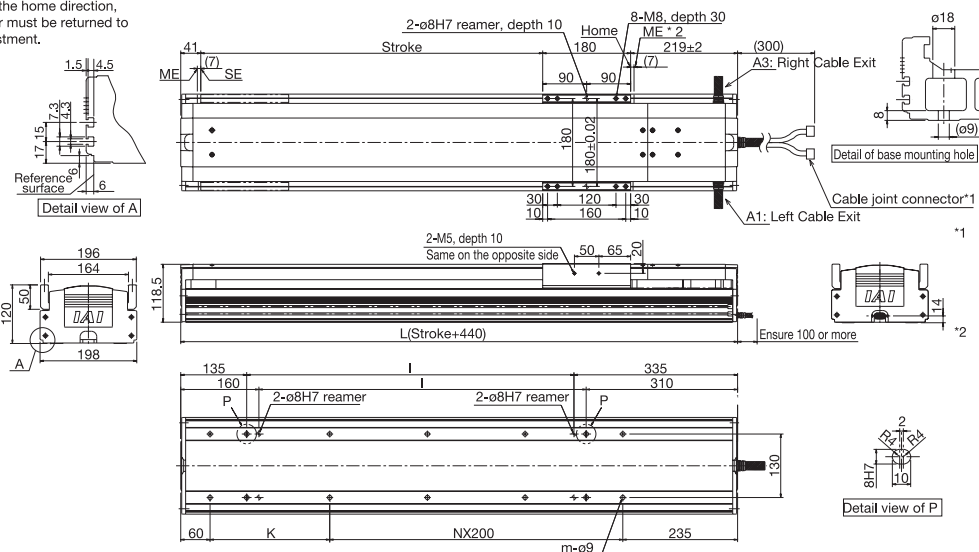

*1 Connect the motor cable and encoder cable here. Refer to page 14 for the details of each cable.
SE: Stroke end
ME: Mechanical end
During home return, the slider will move to the ME, so be careful to prevent contact with surrounding parts.

Dimensions, Weight and Maximum Speed by Stroke

Stroke	100	200	300	400	500	600	700	800	900	1000	1100	1200	1300
L	540	640	740	840	940	1040	1140	1240	1340	1440	1540	1640	1740
I	70	170	270	370	470	570	670	770	870	970	1070	1170	1270
K	245	145	245	145	245	145	245	145	245	145	245	145	245
N	-	1	1	2	2	3	3	4	4	5	5	6	6
m	4	6	6	8	8	10	10	12	12	14	14	16	16
Weight (kg)	18.1	20.1	22.1	24.1	26.1	28.0	30.0	32.0	34.0	35.9	37.9	39.9	41.9
Maximum speed (mm/s)	Lead 40	2400							1840	1530	1290	1100	950
	Lead 20	1200							920	765	645	550	475
	Lead 10	600							460	380	320	270	235

Applicable Controller Specifications

Applicable controller	Maximum number of controlled axes	Compatible encoder type	Operating method	Supply voltage	Page
X-SEL-P/Q	6 axes	Absolute / incremental	Program	Three-Phase AC200V	P14
X-SEL-K	4 axes			AC100/200V	P14
X-SEL-J (Note 8)	4 axes			AC200V	P14
SSEL	2 axes			AC200V	P14
SCON	1 axis			Positioner Pulse train	P14

* The WXM type comes standard with home limit switch, so use it with a controller of the limit switch specification.



(Note 1) When the stroke increases, the maximum speed drops in order to prevent the ball screw from reaching a critical speed. (Refer to the above table for the maximum speed at each stroke.)
(Note 2) Refer to page 4 for the relationship of acceleration and load capacity.
(Note 3, 4, 5) Specs within the [] are for the ISPA series.
(Note 6) For 10,000km actuator life.
(Note 7) The maximum cable length is 30 m. Specify a desired length in meters. (Example: X08 = 8 m)
(Note 8) When using the WXM type actuator for vertical applications, please use the XSEL-J type controller.

ISA-WXM-750

Single-Axis Robot: Super Large X-Axis Long Slider Type, Actuator Width 198mm, 750W, Straight Shape

ISPA-WXM-750

Single-Axis Robot: Super Large X-Axis Long Slider Type, Actuator Width 198mm, 750W, Straight Shape, High-Precision Specification

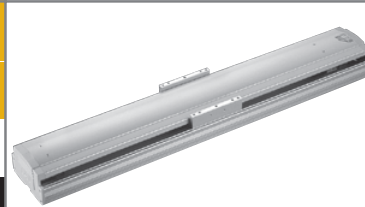

Type Super large X-axis (198-mm wide) Long slider type Stroke 100~1300mm Load capacity 120kg (horizontal)/29kg (vertical)

Model specification items Series Type Encoder type Motor output Lead Stroke Applicable controller Cable length Options
 (Example) ISA -WXM - I - 750 - 50 -1300 - T1 - S -C-L

* Refer to page 3 for the details of model specification items.

Models/Specifications

Model	Encoder Type	Motor output (W)	Lead (mm)	Stroke 100mm increments (mm)	Speed (Note 1) (mm/s)	Acceleration (Note 2)				Load capacity (Note2)				Rated thrust (N)
						Horizontal (G)		Vertical (G)		Horizontal (kg)		Vertical (kg)		
						Rated	Maximum	Rated	Maximum	Rated	Maximum	Rated	Maximum	
ISA [ISPA]-WXM-[1]-750-50-[2]-[3]-[4]-L-[5]	Absolute	750	50	100 ~ 1300	1 ~ 2000	0.3	1.0	0.3	1.0	60	18	14	5	255
ISA [ISPA]-WXM-[1]-750-25-[2]-[3]-[4]-L-[5]	Incremental		25		1 ~ 1250	0.3	1.0	0.3	0.8	120	36	29	15	510

* In the above model names, [1] indicates the encoder type, [2] the stroke, [3] the applicable controller, [4] the cable length, and [5] the applicable options.

Options

Name	Code	Page	Name	Code	Page
AQ seal	AQ	P13	Master-axis designation	LM	P13
Brake	B	P13	Reversed home specification	NM	P13
Creep sensor	C	P13	Slave-axis designation	S	P13
Home limit switch	L	P13	Cable Exit Direction	A1/A3	Diagram Below

* The WXM type comes standard with home limit switch (code: L).

Common Specifications

* The specifications of the ISPA are shown in [].

Positioning repeatability (Note 3)	±0.02mm [±0.01mm]
Drive system (Note 4)	Ball screw ø25mm, equivalent to rolled C10 [equivalent to C5]
Backlash (Note 5)	0.05mm or less [0.02mm or less]
Guide	Integrated with base
Allowable load moment (Note 6)	Ma: 139.2N • m, Mb: 199.9N • m, Mc: 391N • m
Overhang load length	Ma/Mb/Mc directions: 900mm or less
Base	Material: Aluminum with white alumite treatment
Applicable controller	T1: XSEL-J/K, T2: XSEL-P/Q, SSEL, SCON
Cable length (Note 7)	N: No cable, S: 3m, M: 5m, X□□: Length specification
Ambient operating temperature/humidity	0~40°C, 85% RH (non-condensing)

Dimensions

* Those equipped with an optional brake have the same external dimensions, but the weight increases by 0.5 kg.

* To change the home direction, the actuator must be returned to IAI for adjustment.

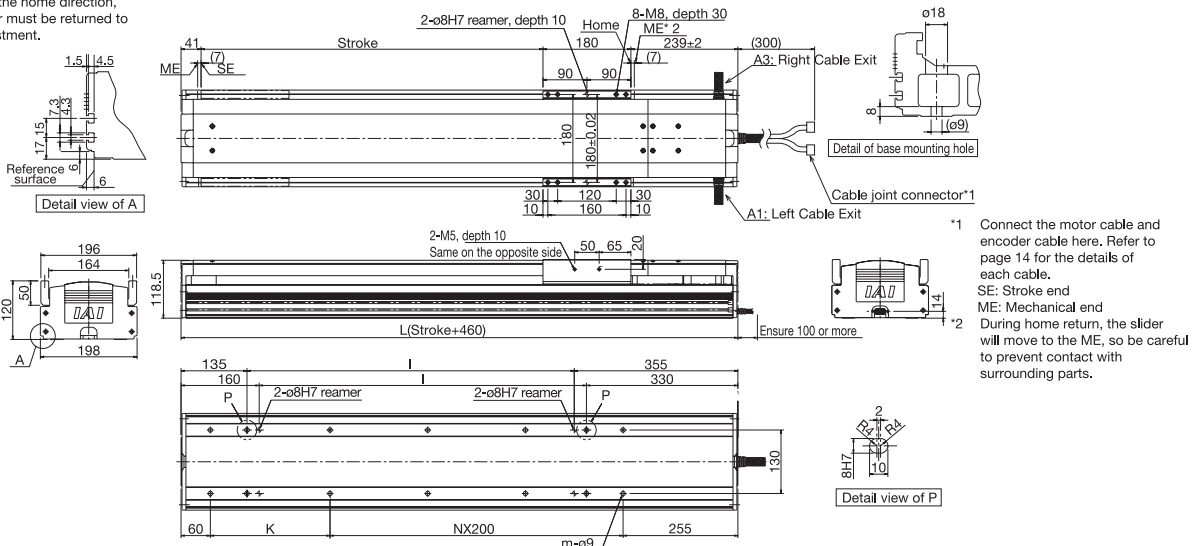

Dimensions, Weight and Maximum Speed by Stroke

Stroke	100	200	300	400	500	600	700	800	900	1000	1100	1200	1300
L	560	660	760	860	960	1060	1160	1260	1360	1460	1560	1660	1760
I	70	170	270	370	470	570	670	770	870	970	1070	1170	1270
K	245	145	245	145	245	145	245	145	245	145	245	145	245
N	-	1	1	2	2	3	3	4	4	5	5	6	6
m	4	6	6	8	8	10	10	12	12	14	14	16	16
Weight (kg)	20.9	22.9	24.9	26.9	28.9	30.8	32.8	34.8	36.8	38.7	40.7	42.7	44.7
Maximum speed (mm/s) * Varies depending on the stroke.	Lead 40	2000								2000	1840	1570	1360
	Lead 25	1250								1090	920	785	680

Applicable Controller Specifications

Applicable controller	Maximum number of controlled axes	Compatible encoder type	Operating method	Supply voltage	Page
X-SEL-P/Q	6 axes	Absolute /incremental	Program	Three-Phase AC200V	P14
X-SEL-K	4 axes			AC100/200V	P14
X-SEL-J (Note 8)	4 axes			AC200V	P14
SSEL	2 axes			AC200V	P14
SCON	1 axis			Positioner Pulse train	P14

* The WXM type comes standard with home limit switch, so use it with a controller of the limit switch specification.

Caution

(Note 1) When the stroke increases, the maximum speed drops in order to prevent the ball screw from reaching a critical speed. (Refer to the above table for the maximum speed at each stroke.)

(Note 2) Refer to page 4 for the relationship of acceleration and load capacity.

(Note 3, 4, 5) Specs within the [] are for the ISPA series.

(Note 6) For 10,000km actuator life.

(Note 7) The maximum cable length is 30 m. Specify a desired length in meters. (Example: X08 = 8 m)

(Note 8) When using the WXM type actuator for vertical applications, please use the XSEL-J type controller.

ISA-WXM-600

Single-Axis Robot: Super Large X-axis Mid-support Type, Actuator Width 198mm, 600W, Straight Shape

ISPA-WXM-600

Single-Axis Robot: Super Large X-axis Mid-support Type, Actuator Width 198mm, 600W, Straight Shape, High-Precision Specification

Type	Super large X-axis (198-mm wide) Mid-support type	Stroke	900~2500mm	Load capacity	120kg (horizontal)
------	---	--------	------------	---------------	--------------------



Model specification items Series Type Encoder type Motor output Lead Stroke Applicable controller Cable length Options
 (Example) ISA -WXM- I - 600 - 40 - 2500 - T1 - S - C - L

* Refer to page 3 for the details of model specification items.

Models/Specifications

Model	Encoder Type	Motor output (W)	Lead (mm)	Stroke 100mm increments (mm)	Speed (Note 1) (mm/s)	Acceleration (Note 2)				Rated thrust (N)		
						Horizontal (G)		Vertical (G)			Load capacity (Note 2)	
						Rated	Maximum	Rated	Maximum		Horizontal (kg)	Vertical (kg)
ISA [ISA]-WXM-[1]-600-40-[2]-[3]-[4]-L-[5]	Absolute	600	40	900 ~ 2500	1 ~ 2400	0.3	Horizontal only		60	255		
ISA [ISA]-WXM-[1]-600-20-[2]-[3]-[4]-L-[5]	Incremental		20		1 ~ 1200	0.3	Horizontal only		120			

* In the above model names, [1] indicates the encoder type, [2] the stroke, [3] the applicable controller, [4] the cable length, and [5] the applicable options.

Options

Name	Code	Page	Name	Code	Page
AQ seal	AQ	P13	Master-axis designation	LM	P13
Brake	B	P13	Reversed home specification	NM	P13
Creep sensor	C	P13	Slave-axis designation	S	P13
Home limit switch	L	P13	Cable Exit Direction	A1/A3	Diagram Below

* The WXM type comes standard with home limit switch (code: L).

Common Specifications

* The specifications of the ISPA are shown in [].

Positioning repeatability (Note 3)	±0.02mm [±0.01mm]
Drive system (Note 4)	Ball screw ø20mm, equivalent to rolled C10 [equivalent to C5]
Backlash (Note 5)	0.05mm or less [0.02mm or less]
Guide	Integrated with base
Allowable load moment (Note 6)	Ma: 139.2N • m, Mb: 199.9N • m, Mc: 391N • m
Overhang load length	Ma/Mb/Mc directions: 900mm or less
Base	Material: Aluminum with white alumite treatment
Applicable controller	T1: XSEL-J/K, T2: XSEL-P/Q, SSEL, SCON
Cable length (Note 7)	N: No cable, S: 3m, M: 5m, X[] []: Length specification
Ambient operating temperature/humidity	0~40°C, 85% RH (non-condensing)

Dimensions

* To change the home direction, the actuator must be returned to IA1 for adjustment.
 * Due to their structure, the mid-support type cannot be positioned horizontally on their side, or in the vertical direction.

* Those equipped with an optional brake have the same external dimensions, but the weight increases by 0.5 kg.

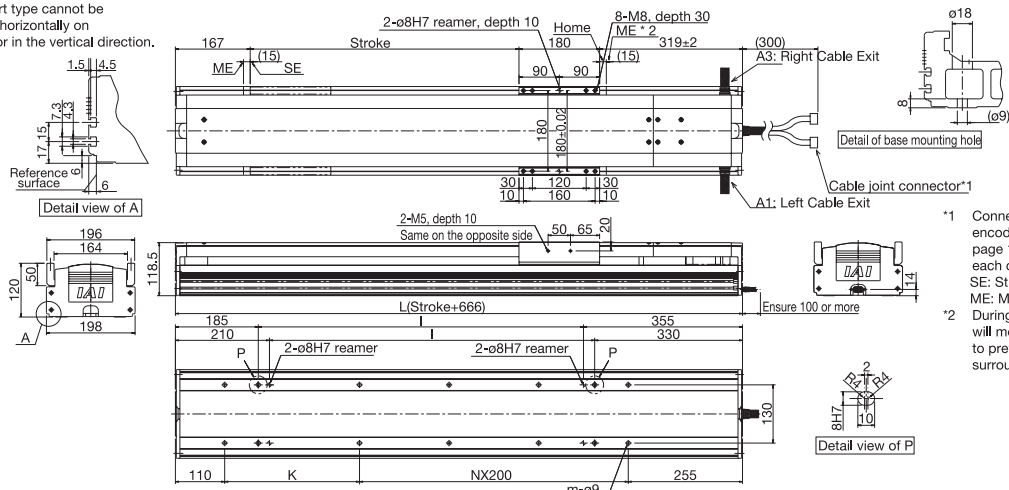

- *1 Connect the motor cable and encoder cable here. Refer to page 14 for the details of each cable.
SE: Stroke end
ME: Mechanical end
During home return, the slider will move to the ME, so be careful to prevent contact with surrounding parts.
- *2

Dimensions, Weight and Maximum Speed by Stroke

Stroke	900	1000	1100	1200	1300	1400	1500	1600	1700	1800	1900	2000	2100	2200	2300	2400	2500
L	1566	1666	1766	1866	1966	2066	2166	2266	2366	2466	2566	2666	2766	2866	2966	3066	3166
I	1026	1126	1226	1326	1426	1526	1626	1726	1826	1926	2026	2126	2226	2326	2426	2526	2626
K	201	301	201	301	201	301	201	301	201	301	201	301	201	301	201	301	201
N	5	5	6	6	7	7	8	8	9	9	10	10	11	11	12	12	13
m	14	14	16	16	18	18	20	20	22	22	24	24	26	26	28	28	30
Weight (kg)	38.6	40.6	42.6	44.6	46.6	48.5	50.5	52.5	54.5	56.5	58.4	60.4	62.4	64.4	66.3	68.3	70.3
Maximum speed (mm/s)	Lead 40	2400			2200	1965	1725	1530	1365	1225	1110	1005	915	840	770	710	655
	Lead 20	1200			1100	980	860	765	680	610	555	500	455	420	385	355	325

Applicable Controller Specifications

Applicable controller	Maximum number of controlled axes	Compatible encoder type	Operating method	Supply voltage	Page
X-SEL-P/Q	6 axes	Absolute /incremental	Program	Three-Phase AC200V	P14
X-SEL-K	4 axes			AC100/200V	P14
X-SEL-J (Note 8)	4 axes			AC200V	P14
SSEL	2 axes				P14
SCON	1 axis				Positioner Pulse train

* The WXM type comes standard with home limit switch, so use it with a controller of the limit switch specification.

Caution

(Note 1) When the stroke increases, the maximum speed drops in order to prevent the ball screw from reaching a critical speed. (Refer to the above table for the maximum speed at each stroke.)
 (Note 2) Refer to page 4 for the relationship of acceleration and load capacity.
 (Note 3, 4, 5) Spaces within the [] are for the ISPA series.
 (Note 6) For 10,000km actuator life.
 (Note 7) The maximum cable length is 30 m. Specify a desired length in meters. (Example: X08 = 8 m)
 (Note 8) When using the WXM type actuator for vertical applications, please use the XSEL-J type controller.

7

ISA/ISPA-WXM-600

ISA-WXMX-750 Single-Axis Robot: Super Large X-axis Mid-support Type, Actuator Width 198mm, 750W, Straight Shape

ISPA-WXMX-750 Single-Axis Robot: Super Large X-axis Mid-support Type, Actuator Width 198mm, 750W, Straight Shape, High-Precision Specification

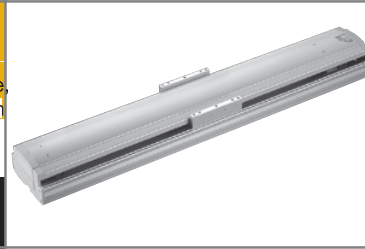

Type	Super large X-axis (198-mm wide) Mid-support type	Stroke	900~2500mm	Load capacity	120kg (horizontal)
Model specification items Series Type Encoder type Motor output Lead Stroke Applicable controller Cable length Options (Example) ISA -WXMX- I - 750 - 50 -2500- T1 - S -C-L					

* Refer to page 3 for the details of model specification items.

Models/Specifications

Model	Encoder Type	Motor output (W)	Lead (mm)	Stroke 100mm increments (mm)	Speed (Note 1) (mm/s)	Acceleration (Note 2)				Rated thrust (N)		
						Horizontal (G)		Vertical (G)			Load capacity (Note 2)	
						Rated	Maximum	Rated	Maximum		Horizontal (kg)	Vertical (kg)
ISA [ISPA]-WXMX-[1]-750-50-[2]-[3]-[4]-L-[5]	Absolute	750	50	900 ~ 2500	1 ~ 2000	0.3	Horizontal only		60	255		
ISA [ISPA]-WXMX-[1]-750-25-[2]-[3]-[4]-L-[5]	Incremental		25		1 ~ 1250	0.3	Horizontal only		120			

* In the above model names, [1] indicates the encoder type, [2] the stroke, [3] the applicable controller, [4] the cable length, and [5] the applicable options.

Options

Name	Code	Page	Name	Code	Page
AQ seal	AQ	P13	Master-axis designation	NM	P13
Brake	B	P13	Reversed home specification	LM	P13
Creep sensor	C	P13	Slave-axis designation	S	P13
Home limit switch	L	P13	Cable Exit Direction	A1/A3	Diagram Below

* The WXM type comes standard with home limit switch (code: L).

Common Specifications

* The specifications of the ISPA are shown in [].

Positioning repeatability (Note 3)	±0.02mm [±0.01mm]
Drive system (Note 4)	Ball screw ø25mm, equivalent to rolled C10 [equivalent to C5]
Backlash (Note 5)	0.05mm or less [0.02mm or less]
Guide	Integrated with base
Allowable load moment (Note 6)	Ma: 139.2N • m, Mb: 199.9N • m, Mc: 391N • m
Overhang load length	Ma/Mb/Mc directions: 900mm or less
Base	Material: Aluminum with white alumite treatment
Applicable controller	T1: XSEL-J/K, T2: XSEL-P/Q, SSEL, SCON
Cable length (Note 7)	N: No cable, S: 3m, M: 5m, X□□: Length specification
Ambient operating temperature/humidity	0~40°C, 85% RH (non-condensing)

Dimensions

* Those equipped with an optional brake have the same external dimensions, but the weight increases by 0.5 kg.

* To change the home direction, the actuator must be returned to IA1 for adjustment.
 * Due to their structure, the mid-support type cannot be positioned horizontally on their side, or in the vertical direction.

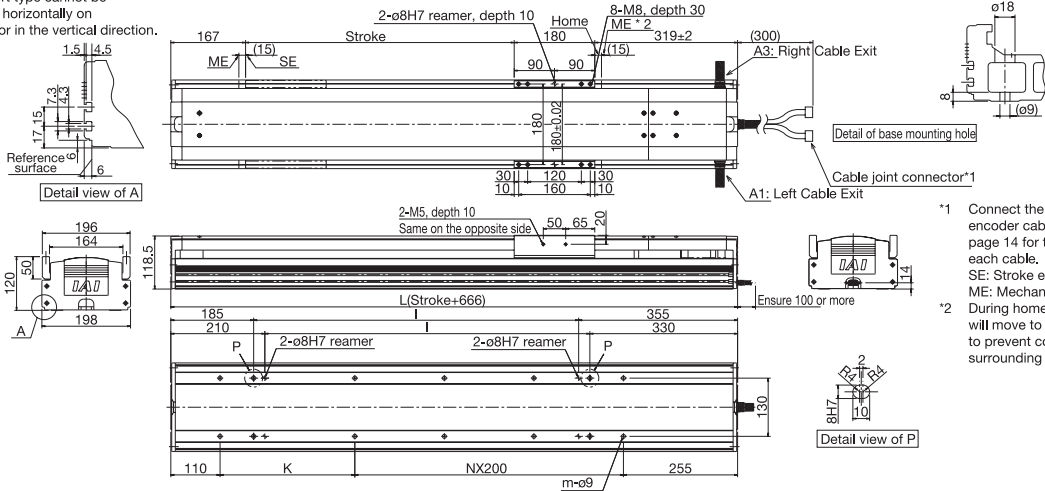

- *1 Connect the motor cable and encoder cable here. Refer to page 14 for the details of each cable.
SE: Stroke end
ME: Mechanical end
- *2 During home return, the slider will move to the ME, so be careful to prevent contact with surrounding parts.

Dimensions, Weight and Maximum Speed by Stroke

Stroke	900	1000	1100	1200	1300	1400	1500	1600	1700	1800	1900	2000	2100	2200	2300	2400	2500	
L	1566	1666	1766	1866	1966	2066	2166	2266	2366	2466	2566	2666	2766	2866	2966	3066	3166	
I	1026	1126	1226	1326	1426	1526	1626	1726	1826	1926	2026	2126	2226	2326	2426	2526	2626	
K	201	301	201	301	201	301	201	301	201	301	201	301	201	301	201	301	201	
N	5	5	6	6	7	7	8	8	9	9	10	10	11	11	12	12	13	
m	14	14	16	16	18	18	20	20	22	22	24	24	26	26	28	28	30	
Weight (kg)	41.4	43.4	45.4	47.4	49.4	51.3	53.3	55.3	57.3	59.3	61.2	63.2	65.2	67.2	69.1	71.1	73.1	
Maximum speed (mm/s) * Varies depending on the stroke.	Lead 50								2000		1930	1740	1580	1440	1320	1210	1115	1035
	Lead 25				1250				1200	1075	965	870	790	720	660	605	555	515

Applicable Controller Specifications

Applicable controller	Maximum number of controlled axes	Compatible encoder type	Operating method	Supply voltage	Page
X-SEL-P/Q	6 axes	Absolute /incremental	Program	Three-Phase AC200V	P14
X-SEL-K	4 axes			AC100/200V	P14
X-SEL-J (Note 8)	4 axes			AC200V	P14
SSEL	2 axes				P14
SCON	1 axis				Positioner Pulse train

* The WXM type comes standard with home limit switch, so use it with a controller of the limit switch specification.

Caution

(Note 1) When the stroke increases, the maximum speed drops in order to prevent the ball screw from reaching a critical speed. (Refer to the above table for the maximum speed at each stroke.)
 (Note 2) Refer to page 4 for the relationship of acceleration and load capacity.
 (Note 3, 4, 5) Specs within the [] are for the ISPA series.
 (Note 6) For 10,000km actuator life.
 (Note 7) The maximum cable length is 30 m. Specify a desired length in meters. (Example: X08 = 8 m)
 (Note 8) When using the WXM type actuator for vertical applications, please use the XSEL-J type controller.

ISDACR-W-600

Single-Axis Robot: Super Large Cleanroom Type,
Actuator Width 198mm, 600W, Straight Shape

ISPDACR-W-600

Single-Axis Robot: Super Large Cleanroom Type,
Actuator Width 198mm, 600W, Straight Shape, High-Precision Specification

Type / Super large (198-mm wide) Stroke / 100-1300mm Load capacity / 150kg (horizontal)/60kg (vertical)



Model specification items Series Type Encoder type Motor output Lead Stroke Applicable controller Cable length Options
 (Example) ISDACR -W- A - 600 - 40 -1300- T1 - S -L-NM

* Refer to page 3 for the details of model specification items.

Models/Specifications

Model	Encoder Type	Motor output (W)	Lead (mm)	Stroke 100mm increments (mm)	Speed (Note 1) (mm/s)	Acceleration (Note 2)				Load capacity (Note 2)				Rated thrust (N)	Suction rate (Nℓ/min)
						Horizontal (G)		Vertical (G)		Horizontal (kg)		Vertical (kg)			
						Rated	Maximum	Rated	Maximum	Rated acceleration	Maximum acceleration	Rated acceleration	Maximum acceleration		
ISDACR [ISPDACR]-W-[1]-600-40-[2]-[3]-[4]-L-[5]	Absolute Incremental	600	40	100 ~ 1300	1 ~ 2000	0.3	1.0	0.3	1.0	60	18	14	5	255	120
ISDACR [ISPDACR]-W-[1]-600-20-[2]-[3]-[4]-L-[5]			20		1 ~ 1000	0.3	1.0	0.3	0.8	120	36	29	15	510	60
ISDACR [ISPDACR]-W-[1]-600-10-[2]-[3]-[4]-L-[5]			10		1 ~ 500	0.3	0.6	0.3	0.5	150	75	60	40	1020	40

* In the above model names, [1] indicates the encoder type, [2] the stroke, [3] the applicable controller, [4] the cable length, and [5] the applicable options.

Options

Name	Code	Page	Name	Code	Page
AQ seal	AQ	P13	Master-axis designation	LM	P13
Brake	B	P13	Reversed home specification	NM	P13
Creep sensor	C	P13	Slave-axis designation	S	P13
Home limit switch	L	P13	Suction duct joint on opposite side	VR	P13

* The W type comes standard with home limit switch (code: L).

Common Specifications

* The specifications of the ISPDACR are shown in [].

Positioning repeatability (Note 3)	±0.02mm [±0.01mm]
Drive system (Note 4)	Ball screw ø20mm, equivalent to rolled C10 [equivalent to C5]
Backlash (Note 5)	0.05mm or less [0.02mm or less]
Guide	Integrated with base
Grease	Low dust-raising grease (for both ball screw and guide)
Allowable load moment	Ma: 112.7N • m, Mb: 161.7N • m, Mc: 356.7N • m
Overhand load moment (Note 6)	Ma/Mb/Mc directions: 800mm or less
Base	Material: Aluminum with white alumite treatment
Applicable controller	T1: XSEL-J/K T2: XSEL-P/Q, SSEL, SCON
Cable length	N: No cable, S: 3m, M: 5m, X[] []: Length specification
Cleanliness class	Conforming to class 10 (0.1µm)
Suction duct joint	Quick duct joint with applicable tube outer diameter of ø12

Dimensions

* To change the home direction, the actuator must be returned to IAI for adjustment.

* Those equipped with an optional brake have the same external dimensions, but the weight increases by 0.5 kg.

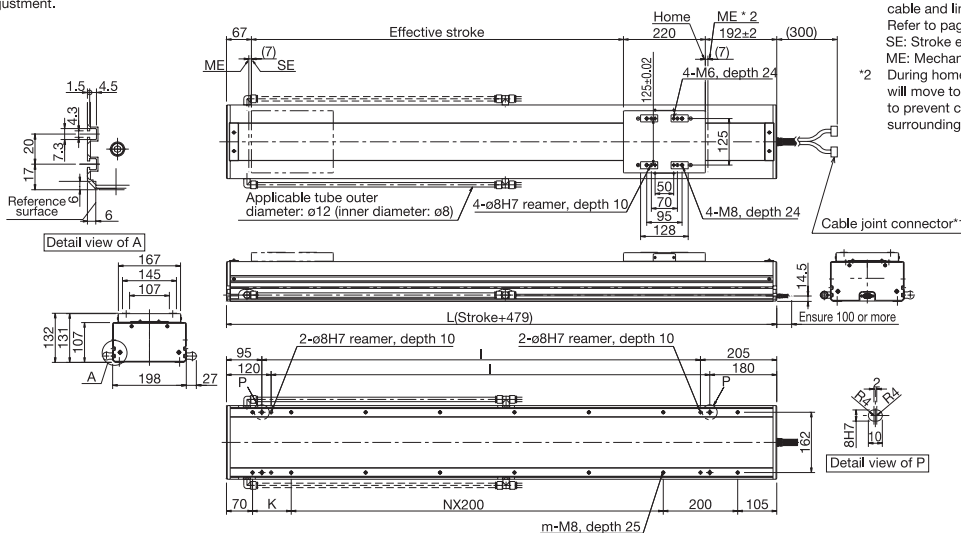

- *1 Connect the motor cable, encoder cable and limit switch cables here. Refer to page 14 for the details of each cable. SE: Stroke end ME: Mechanical end
- *2 During home return, the slider will move to the ME, so be careful to prevent contact with surrounding parts.

Dimensions, Weight and Maximum Speed by Stroke

Stroke	100	200	300	400	500	600	700	800	900	1000	1100	1200	1300																			
L	579	679	779	879	979	1079	1179	1279	1379	1479	1579	1679	1779																			
I	279	379	479	579	679	779	879	979	1079	1179	1279	1379	1479																			
K	204	104	204	104	204	104	204	104	204	104	204	104	204																			
N	0	1	1	2	2	3	3	4	4	5	5	6	6																			
m	6	8	8	10	10	12	12	14	14	16	16	18	18																			
Weight (kg)	19.4	21.5	23.5	25.5	27.6	29.6	31.6	33.7	35.7	37.7	39.8	41.8	43.8																			
Maximum speed (mm/s)	Lead 40				2000				1965				1605				1335				1130				970				840			
	Lead 20				1000				980				800				665				565				485				420			
	Lead 10				500				490				400				330				280				240				210			

Applicable Controller Specifications

Applicable controller	Maximum number of controlled axes	Compatible encoder type	Operating method	Supply voltage	Page
X-SEL-P/Q	6 axes	Absolute /incremental	Program	Three-Phase AC200V	P14
X-SEL-K	4 axes			AC100/200V	P14
X-SEL-J (Note 8)	4 axes			P14	
SSEL	2 axes			AC200V	P14
SCON	1 axis			Positioner Pulse train	P14

* The W type comes standard with home limit switch, so use it with a controller of the limit switch specification.

Caution

(Note 1) When the stroke increases, the maximum speed drops in order to prevent the ball screw from reaching a critical speed. (Refer to the above table for the maximum speed at each stroke.)

(Note 2) Refer to page 4 for the relationship of acceleration and load capacity.

(Note 3, 4, 5) Specs within the [] are for the ISPA series.

(Note 6) For 10,000km actuator life.

(Note 7) The maximum cable length is 30 m. Specify a desired length in meters. (Example: X08 = 8 m)

(Note 8) When using the WXM type actuator for vertical applications, please use the XSEL-J type controller.

ISDPCR-W-750

Single-Axis Robot: Super Large Cleanroom Type,
Actuator Width 198mm, 750W, Straight Shape

ISPDPCR-W-750

Single-Axis Robot: Super Large Cleanroom Type,
Actuator Width 198mm, 750W, Straight Shape, High-Precision Specification

Type Super large (198-mm wide)

Stroke 100~1300mm

Load capacity 120kg (horizontal)/29kg (vertical)



Model specification items Series Type Encoder type Motor output Lead Stroke Applicable controller Cable length Options
(Example) ISDPCR -W- A - 750 - 50 -1300- T1 - S -L-NM

* Refer to page 3 for the details of model specification items.

Models/Specifications

Model	Encoder Type	Motor output (W)	Lead (mm)	Stroke 100mm increments (mm)	Speed (Note 1) (mm/s)	Acceleration (Note 2)				Load capacity (Note 2)				Rated thrust (N)	Suction rate (NL/min)
						Horizontal (G)		Vertical (G)		Horizontal (kg)		Vertical (kg)			
						Rated	Maximum	Rated	Maximum	Rated	Maximum	Rated	Maximum		
ISDPCR [ISPDPCR]-W-[]-750-50-[2]-[3]-[4]-L-[5]	Absolute	750	50	100 ~ 1300	1 ~ 2000	0.3	1.0	0.3	1.0	60	18	14	5	255	120
ISDPCR [ISPDPCR]-W-[]-750-25-[2]-[3]-[4]-L-[5]	Incremental		25		1 ~ 1250	0.3	1.0	0.3	0.8	120	36	29	15	510	60

* In the above model names, [1] indicates the encoder type, [2] the stroke, [3] the applicable controller, [4] the cable length, and [5] the applicable options.

Options

Name	Code	Page	Name	Code	Page
AQ seal	AQ	P13	Master-axis designation	LM	P13
Brake	B	P13	Reversed home specification	NM	P13
Creep sensor	C	P13	Slave-axis designation	S	P13
Home limit switch	L	P13	Suction duct joint on opposite side	VR	P13

* The W type comes standard with home limit switch (code: L).

Common Specifications

* The specifications of the ISPDPCR are shown in [].

Positioning repeatability (Note 3)	±0.02mm [±0.01mm]
Drive system (Note 4)	Ball screw ø25mm, equivalent to rolled C10 [equivalent to C5]
Backlash (Note 5)	0.05mm or less [0.02mm or less]
Guide	Integrated with base
Grease	Low dust-raising grease (for both ball screw and guide)
Allowable load moment	Ma: 112.7N • m, Mb: 161.7N • m, Mc: 356.7N • m
Overhand load moment (Note 6)	Ma/Mb/Mc directions: 800mm or less
Base	Material: Aluminum with white alumite treatment
Applicable controller	T1: XSEL-J/K T2: XSEL-P/Q, SSEL, SCON
Cable length	N: No cable, S: 3m, M: 5m, X[] []: Length specification
Cleanliness class	Conforming to class 10 (0.1µm)
Suction duct joint	Quick duct joint with applicable tube outer diameter of ø12

Dimensions

* To change the home direction, the actuator must be returned to IAI for adjustment.
* Those equipped with an optional brake have the same external dimensions, but the weight increases by 0.5 kg.

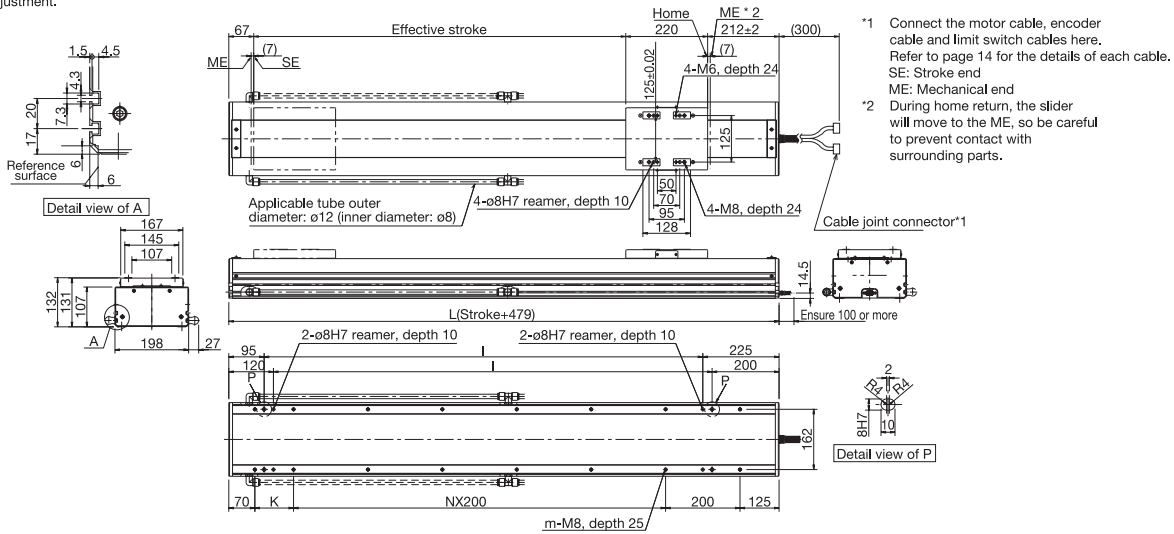

Dimensions, Weight and Maximum Speed by Stroke

Stroke	100	200	300	400	500	600	700	800	900	1000	1100	1200	1300
L	599	699	799	899	999	1099	1199	1299	1399	1499	1599	1699	1799
I	279	379	479	579	679	779	879	979	1079	1179	1279	1379	1479
K	204	104	204	104	204	104	204	104	204	104	204	104	204
N	0	1	1	2	2	3	3	4	4	5	5	6	6
m	6	8	8	10	10	12	12	14	14	16	16	18	18
Weight (kg)	23.4	25.5	27.5	29.5	31.6	33.6	35.6	37.7	39.7	41.7	43.8	45.8	47.8
Maximum speed (mm/s) * Varies depending on the stroke.	Lead 50	2000									1780	1525	1320
	Lead 25	1250									1050	890	760

Applicable Controller Specifications

Applicable controller	Maximum number of controlled axes	Compatible encoder type	Operating method	Supply voltage	Page
X-SEL-P/Q	6 axes	Absolute /incremental	Program	Three-Phase AC200V	P14
X-SEL-K	4 axes			AC100/200V	P14
X-SEL-J (Note 8)	4 axes				P14
SSEL	2 axes			AC200V	P14
SCON	1 axis			Positioner Pulse train	P14

* The W type comes standard with home limit switch, so use it with a controller of the limit switch specification.

Caution

(Note 1) When the stroke increases, the maximum speed drops in order to prevent the ball screw from reaching a critical speed. (Refer to the above table for the maximum speed at each stroke.)

(Note 2) Refer to page 4 for the relationship of acceleration and load capacity.

(Note 3, 4, 5) Specs within the [] are for the ISPA series.

(Note 6) For 10.000km actuator file.

(Note 7) The maximum cable length is 30 m. Specify a desired length in meters. (Example: X08 = 8 m)

(Note 8) When using the WXM type actuator for vertical applications, please use the XSEL-J type controller.

ISDACR-WX-600

Single-Axis Robot: Super Large Cleanroom Mid-Support Type, Actuator Width 198mm, 600W, Straight Shape

ISPDACR-WX-600

Single-Axis Robot: Super Large Cleanroom Mid-Support Type, Actuator Width 198mm, 600W, Straight Shape, High-Precision Specification

Type / Super large (198-mm wide)	Stroke / 900-2500mm	Load capacity / 120kg (horizontal)
----------------------------------	---------------------	------------------------------------



Model specification items Series Type Encoder type Motor output Lead Stroke Applicable controller Cable length Options

(Example) ISDACR - WX - A - 600 - 40 - 2500 - T1 - S - B

* Refer to page 3 for the details of model specification items.

Models/Specifications

* 1.0G=9800mm/sec² * Use the mid-support type at the rated acceleration or below.

Model	Encoder Type	Motor output (W)	Lead (mm)	Stroke 100mm increments (mm)	Speed (Note 1) (mm/s)	Acceleration (Note 2)		Load capacity (Note 2)		Rated thrust (N)	Suction rate (Nl/min)
						Horizontal (G)	Vertical (G)	Horizontal (kg)	Vertical (kg)		
						Rated	Maximum	Rated	Maximum		
ISDACR [ISPDACR]-WX-[1]-600-40-[2]-[3]-[4]-L-[5]	Absolute	600	40	900 ~ 2500	1 ~ 2000	0.3	Horizontal Use Only	60	Horizontal Use Only	255	120
ISDACR [ISPDACR]-WX-[1]-600-20-[2]-[3]-[4]-L-[5]	Incremental		20		1 ~ 1000						

* In the above model names, [1] indicates the encoder type, [2] the stroke, [3] the applicable controller, [4] the cable length, and [5] the applicable options.

Options

Name	Code	Page	Name	Code	Page
AQ seal	AQ	P13	Master-axis designation	LM	P13
Brake	B	P13	Reversed home specification	NM	P13
Creep sensor	C	P13	Slave-axis designation	S	P13
Home limit switch	L	P13	Suction duct joint on opposite side	VR	P13

* The WX type comes standard with home limit switch (code: L).

Common Specifications

* The specifications of the ISPDACR are shown in [].

Positioning repeatability (Note 3)	±0.02mm [±0.01mm]
Drive system (Note 4)	Ball screw ø20mm, equivalent to rolled C10 [equivalent to C5]
Backlash (Note 5)	0.05mm or less [0.02mm or less]
Guide	Integrated with base
Grease	Low dust-raising grease (for both ball screw and guide)
Allowable load moment	Ma: 112.7N • m, Mb: 161.7N • m, Mc: 356.7N • m
Overhand load moment (Note 6)	Ma/Mb/Mc directions: 800mm or less
Base	Material: Aluminum with white alumite treatment
Applicable controller	T1: XSEL-J/K T2: XSEL-P/Q, SSEL, SCON
Cable length	N: No cable, S: 3m, M: 5m, X[] []: Length specification
Cleanliness class	Conforming to class 10 (0.1µm)
Suction duct joint	Quick duct joint with applicable tube outer diameter of ø12

Dimensions

* Those equipped with an optional brake have the same external dimensions, but the weight increases by 0.5 kg.

* To change the home direction, the actuator must be returned to IAI for adjustment.

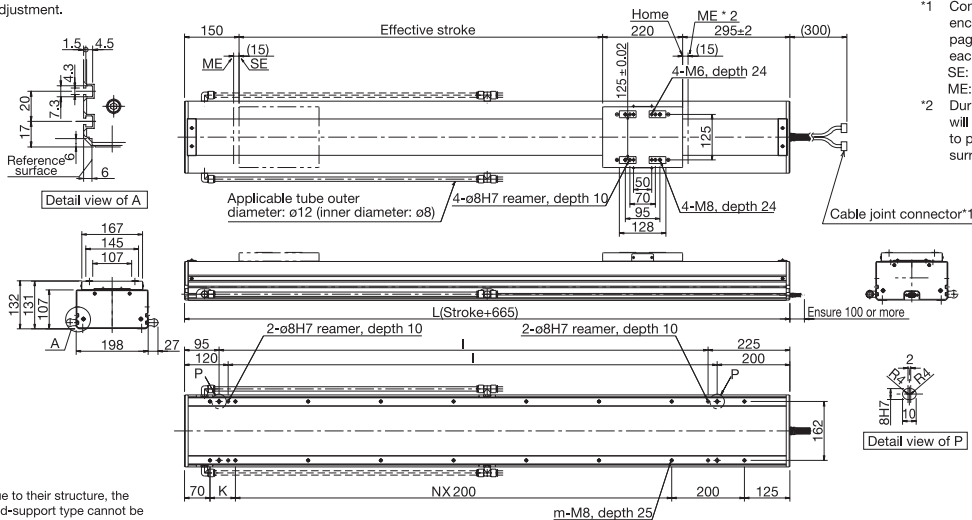

- 1 Connect the motor cable and encoder cable here. Refer to page 14 for the details of each cable.
SE: Stroke end
ME: Mechanical end
- 2 During home return, the slider will move to the ME, so be careful to prevent contact with surrounding parts.

* Due to their structure, the mid-support type cannot be positioned horizontally on their side, or in the vertical direction.

Dimensions, Weight and Maximum Speed by Stroke

Stroke	900	1000	1100	1200	1300	1400	1500	1600	1700	1800	1900	2000	2100	2200	2300	2400	2500
L	1565	1665	1765	1865	1965	2065	2165	2265	2365	2465	2565	2665	2765	2865	2965	3065	3165
I	1245	1345	1445	1545	1645	1745	1845	1945	2045	2145	2245	2345	2445	2545	2645	2745	2845
K	170	70	170	70	170	70	170	70	170	70	170	70	170	70	170	70	170
N	5	6	6	7	7	8	8	9	9	10	10	11	11	12	12	13	13
m	16	18	18	20	20	22	22	24	24	26	26	28	28	30	30	32	32
Weight (kg)	39.5	41.5	43.6	45.6	47.6	49.7	51.7	53.8	55.8	57.8	59.9	61.9	63.9	66.0	68.0	70.0	72.1
Maximum speed (mm/s) * Varies depending on the stroke.	Lead 40	2000				1965	1725	1530	1365	1225	1110	1005	915	840	770	710	655
	Lead 20	1000				980	860	765	680	610	555	500	455	420	385	355	325

Applicable Controller Specifications

Applicable controller	Maximum number of controlled axes	Compatible encoder type	Operating method	Supply voltage	Page
X-SEL-P/Q	6 axes	Absolute / incremental	Program	Three-Phase AC200V	P14
X-SEL-K	4 axes			AC100/200V	P14
X-SEL-J (Note 8)	4 axes			P14	
SSEL	2 axes			AC200V	P14
SCON	1 axis			Positioner Pulse train	P14

* The WX type comes standard with home limit switch, so use it with a controller of the limit switch specification.



- (Note 1) When the stroke increases, the maximum speed drops in order to prevent the ball screw from reaching a critical speed. (Refer to the above table for the maximum speed at each stroke.)
- (Note 2) Refer to page 4 for the relationship of acceleration and load capacity.
- (Note 3, 4, 5) Specs within the [] are for the ISPA series.
- (Note 6) For 10,000km actuator life.
- (Note 7) The maximum cable length is 30 m. Specify a desired length in meters.
(Example: X08 = 8 m)
- (Note 8) When using the WXM type actuator for vertical applications, please use the XSEL-J type controller.

11

ISDACR/ISPDACR-WX-600

ISDACR-WX-750

Single-Axis Robot: Super Large Cleanroom Mid-Support Type, Actuator Width 198mm, 750W, Straight Shape

ISPDACR-WX-750

Single-Axis Robot: Super Large Cleanroom Mid-Support Type, Actuator Width 198mm, 750W, Straight Shape, High-Precision Specification



Type / Super large (198-mm wide) Stroke / 900-2500mm Load capacity / 120kg (horizontal)

Model specification items Series Type Encoder type Motor output Lead Stroke Applicable controller Cable length Options
 (Example) ISDACR -WX- A - 750 -50 -2500- T1 - S - B

* Refer to page 3 for the details of model specification items.

Models/Specifications

* 1.0G=9800mm/sec² * Use the mid-support type at the rated acceleration or below.

Model	Encoder Type	Motor output (W)	Lead (mm)	Stroke 100mm increments (mm)	Speed (Note 1) (mm/s)	Acceleration (Note 2)		Load capacity (Note 2)		Rated thrust (N)	Suction rate (Nl/min)
						Horizontal (G)	Vertical (G)	Horizontal (kg)	Vertical (kg)		
						Rated Maximum	Rated Maximum	Rated Maximum	Rated Maximum		
ISDACR [ISPDACR]-WX-[1]-750-50-[2]-[3]-[4]-L-[5]	Absolute	750	50	900 ~ 2500	1 ~ 2000	0.3	Horizontal Use Only	60	Horizontal Use Only	255	120
ISDACR [ISPDACR]-WX-[1]-750-25-[2]-[3]-[4]-L-[5]	Incremental		25		1 ~ 1250	0.3		120		510	60

* In the above model names, [1] indicates the encoder type, [2] the stroke, [3] the applicable controller, [4] the cable length, and [5] the applicable options.

Options

Name	Code	Page	Name	Code	Page
AQ seal	AQ	P13	Master-axis designation	LM	P13
Brake	B	P13	Reversed home specification	NM	P13
Creep sensor	C	P13	Slave-axis designation	S	P13
Home limit switch	L	P13	Suction duct joint on opposite side	VR	P13

* The WX type comes standard with home limit switch (code: L).

Common Specifications

* The specifications of the ISPDACR are shown in [].

Positioning repeatability (Note 3)	±0.02mm [±0.01mm]
Drive system (Note 4)	Ball screw ø25mm, equivalent to rolled C10 [equivalent to C5]
Backlash (Note 5)	0.05mm or less [0.02mm or less]
Guide	Integrated with base
Grease	Low dust-raising grease (for both ball screw and guide)
Allowable load moment	Ma: 112.7N • m, Mb: 161.7N • m, Mc: 356.7N • m
Overhand load moment (Note 6)	Ma/Mb/Mc directions: 800mm or less
Base	Material: Aluminum with white alumite treatment
Applicable controller	T1: XSEL-J/K T2: XSEL-P/Q, SSEL, SCON
Cable length	N: No cable, S: 3m, M: 5m, X []: Length specification
Cleanliness class	Conforming to class 10 (0.1µm)
Suction duct joint	Quick duct joint with applicable tube outer diameter of ø12

Dimensions

* Those equipped with an optional brake have the same external dimensions.

* To change the home direction, the actuator must be returned to IAI for adjustment.

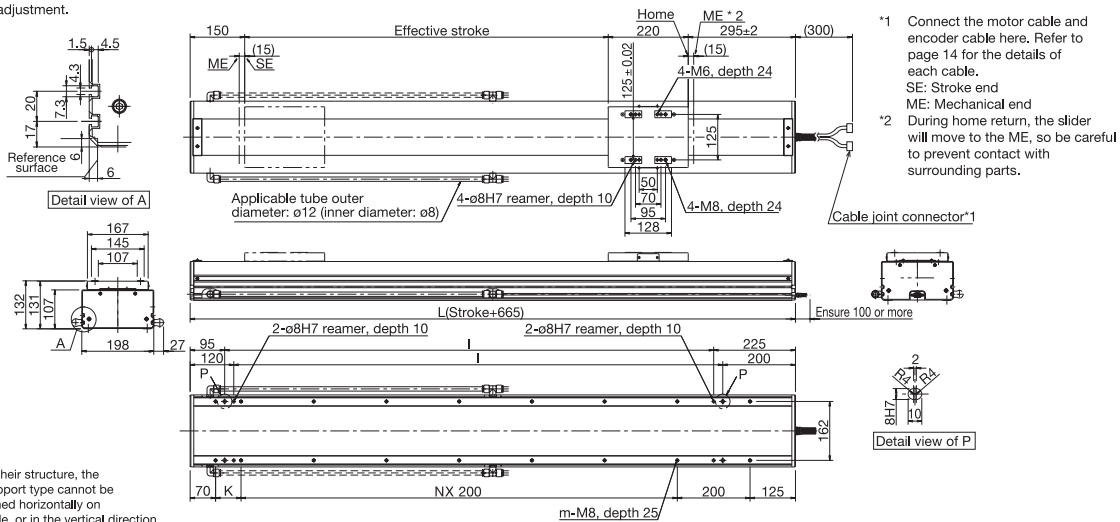

* Due to their structure, the mid-support type cannot be positioned horizontally on their side, or in the vertical direction.

Dimensions, Weight and Maximum Speed by Stroke

Stroke	900	1000	1100	1200	1300	1400	1500	1600	1700	1800	1900	2000	2100	2200	2300	2400	2500													
L	1565	1665	1765	1865	1965	2065	2165	2265	2365	2465	2565	2665	2765	2865	2965	3065	3165													
I	1245	1345	1445	1545	1645	1745	1845	1945	2045	2145	2245	2345	2445	2545	2645	2745	2845													
K	170	70	170	70	170	70	170	70	170	70	170	70	170	70	170	70	170													
N	5	6	6	7	7	8	8	9	9	10	10	11	11	12	12	13	13													
m	16	18	18	20	20	22	22	24	24	26	26	28	28	30	30	32	32													
Weight (kg)	44.5	46.5	48.6	50.6	52.6	54.7	56.7	58.8	60.8	62.8	64.9	66.9	68.9	71.0	73.0	75.0	77.1													
Maximum speed (mm/s)	Lead 50										2000																			
* Varies depending on the stroke.	Lead 25										1200		1075		965		870		790		720		660		605		555		515	

Applicable Controller Specifications

Applicable controller	Maximum number of controlled axes	Compatible encoder type	Operating method	Supply voltage	Page
X-SEL-P/Q	6 axes	Absolute /incremental	Program	Three-Phase AC200V	P14
X-SEL-K	4 axes			AC100/200V	P14
X-SEL-J (Note 8)	4 axes			AC200V	P14
SSEL	2 axes			AC200V	P14
SCON	1 axis			Positioner Pulse train	P14

* The WX type comes standard with home limit switch, so use it with a controller of the limit switch specification.



(Note 1) When the stroke increases, the maximum speed drops in order to prevent the ball screw from reaching a critical speed. (Refer to the above table for the maximum speed at each stroke.)
 (Note 2) Refer to page 4 for the relationship of acceleration and load capacity.
 (Note 3, 4, 5) Specs within the [] are for the ISPA series.
 (Note 6) For 10,000km actuator life.
 (Note 7) The maximum cable length is 30 m. Specify a desired length in meters. (Example: X08 = 8 m)
 (Note 8) When using the WXM type actuator for vertical applications, please use the XSEL-J type controller.

AQ Seal

Code AQ

Explanation The AQ seal is a lubrication unit that uses lubricating material made of resin-solidified lubricating oil. The porous material impregnated with a large amount of lubricating oil slowly releases oil from its surface via capillary effect. The guide and ball screw surfaces (steel-ball rolling surface) are constantly lubricated as AQ seals are pressed against these surfaces. When used with grease, AQ seals enable maintenance-free operation for a long period.

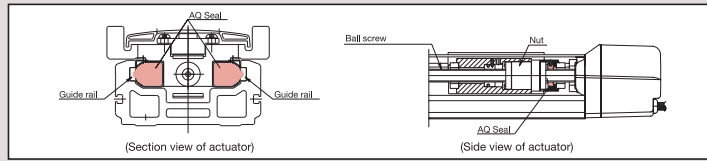

Brake

Code B

Explanation A retention mechanism that prevents the slider from falling and consequently damaging the load when the power or servo is turned off in a vertical actuator application.

Creep Sensor

Code C

Explanation This sensor is used to perform high-speed home return. During home return, the slider normally contacts the stopper at the motor-side stroke end and then reverses its direction. For this reason, the homing speed is limited to 10 to 20 mm/s and it therefore takes time to complete home return when the stroke is long. This proximity sensor is used to shorten the time by allowing the slider to return at high speed until immediately before the home and then reduce its speed to the normal homing speed. Since this sensor is built into the actuator, the actuator dimensions remain the same.

Home Limit Switch

Code L

Explanation Single-axis robots normally perform home return based on the “contact method” whereby the slider contacts the stopper and then reverses its direction, after which phase Z is detected and the corresponding position is set as the home. When option L (home limit switches) is specified, home return is performed with the slider reversing not upon contact, but upon detection by a proximity sensor. Specifying option L adds the three proximity sensors of HOME (for home detection), +OT (for overtravel detection on motor side) and -OT (for overtravel detection on counter-motor side) to the actuator. (The HOME and -OT sensors are provided as an integrated twin sensor.) Super-large types that generate high thrust come standard with option L for safety reasons. The limit switch is also built into the actuator, just like the creep sensor.

Master-Axis Designation for Synchronized Operation

Code LM

Explanation “Synchronized operation” is one of the functions provided by the X-SEL controller. This function allows two actuator axes to be operated simultaneously, with one axis functioning as the master (code: M) and the other as the slave (code: S). By causing the slave to follow the master via ultra high-speed control, the two axes operate virtually simultaneously. The two synchronized actuator axes must be of the exact same specifications (type, lead, motor output and stroke). When synchronized operation is to be performed, the master axis must have limit switch. Accordingly, add LM (master-axis specification with limit switch) to the model of the master axis and S (slave-axis specification) to the model of the slave axis.

Reversed Home Specification

Code NM

Explanation The standard home direction is on the motor side. To change the home direction, the encoder must be adjusted. Should you require the reversed home specification, specify this option in your order.

Slave-Axis Designation for Synchronized Operation

Code S

Explanation Specify this code for the slave axis in synchronized operation (refer to the explanation of “LM”).

Suction Duct Joint on Opposite Side (ISDACR and ISPDACR Only)

Code VR

Explanation The standard position of the air suction joint is on the left side when viewed from the motor, and this option is to change the position to the opposite side (right side).

Controller

A controller of program, positioner or pulse-train input type can be selected in accordance with the control method suitable for your application.

* Refer to the separate catalogs for the details of the controllers.

Program Operation Type
[X-SEL Controller]

A high-functional, multi-axis controller supporting Super SEL Language - a programming language that enables easy programming of complex operations.

- [Features]
- Simultaneous control of up to 6 axes
 - Registration of up to 64 programs/3000 positions
 - Absolute or Incremental specification
 - Compatible with DeviceNet, CC-Link, ProfiBus and Ethernet
 - CE Mark certified



SSEL Controller

A 2-axes positioner that enables easy positioning operation. The SSEL program controller has various control functions combined into a single unit.

- [Features]
- Up to 1,500 positioning points
 - Support of both absolute and incremental actuators and Ethernet
 - With 2 axes, arc interpolation and path operation can be performed



SCON Controller

Position controller capable of 1 axis control.

- [Features]
- Supports up to 512 positioning points
 - DeviceNet, CC-Link specifications (optional)
 - Pulse converter option



Motor Cable/ Encoder Cable

* In □□□, enter a desired cable length (L) up to 30 m. (Example: 080 = 8 m)

Motor Cable (XSEL-J/K/P/Q, SSEL, SCON)

[Model: CB-X-MA□□□]

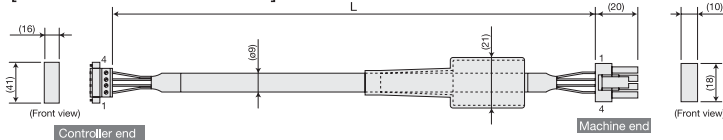

Wiring Diagram

Wire	Color	Signal	No.	No.	Signal	Color	Wire
0.75sq	Green	PE	1	1	U	Green	0.75sq (crimped)
	Red	U	2	2	V	Red	
	White	V	3	3	W	White	
	Black	W	4	4	PE	Black	

Encoder Cable (XSEL-J/K)

[Model: CB-X-PA□□□]

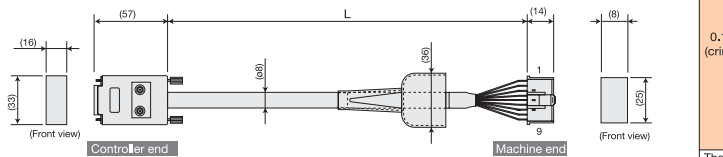

Wiring Diagram

Wire	Color	Signal	No.	No.	Signal	Color	Wire
0.15sq (crimped)	—	—	1	1	BAT+	Black	0.15sq (crimped)
	Blue	SD	7	2	BAT-	Yellow	
	Orange	SD	8	3	SD	Blue	
	Black	BAT+	9	4	SD	Orange	
	Yellow	BAT-	10	5	VCC	Green	
	Green	VCC	11	6	GND	Brown	
	Brown	GND	12	7	FG	Ground	
	Gray	BK-	13	8	BK+	Gray	
	Red	BK+	14	9	BK-	Red	
	—	—	15	—	—	—	

The shield is clamped to the hood. Drain wire and shielded and braided wire.

Limit Switch Cable (XSEL-J/K)

[Model: CB-X-LC□□□]

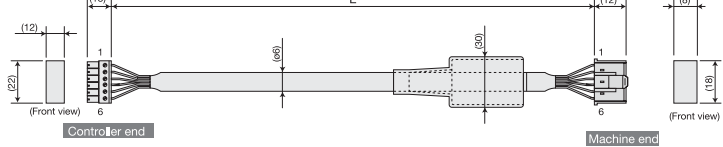

Wiring Diagram

Wire	Color	Signal	No.	No.	Signal	Color	Wire
AWG24	light blue	Z4VOUT	6	1	Z4VOUT	light blue	AWG24 (crimped)
	Pink	N	5	2	N	Pink	
	Light green	LS	4	3	LS	Light green	
	Orange	CREEP	3	4	CREEP	Orange	
	Gray	OT	2	5	OT	Gray	
	light blue	RSV	1	6	RSV	light blue	

Note) "1B" indicates one black dot.

Encoder Cable (XSEL-P/Q, SSEL, SCON)

[Model: CB-X1-PA□□□]

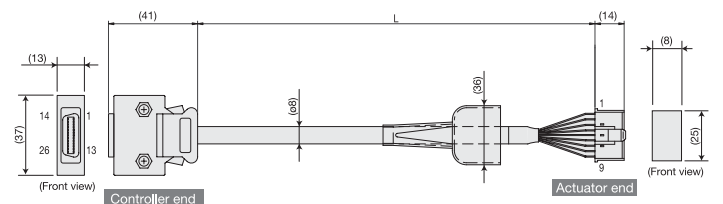

Wiring Diagram

Wire	Color	Signal	No.	No.	Signal	Color	Wire
AWG26 (soldered)	—	—	10	1	BAT +	Purple	AWG26 (crimped)
	—	—	11	2	BAT -	Gray	
	—	E24V	12	3	SD	Orange	
	—	OV	13	4	SD	Green	
	—	LS	26	5	VCC	Red	
	—	CREEP	25	6	GND	Black	
	—	OT	24	7	FG	Ground	
	—	RSV	23	8	BK-	Blue	
	—	—	9	9	BK+	Yellow	
	—	—	18	—	—	—	
	—	—	19	—	—	—	
	—	A+	1	—	—	—	
	—	A-	2	—	—	—	
	—	B+	3	—	—	—	
	—	B-	4	—	—	—	
	—	Z+	5	—	—	—	
	—	Z-	6	—	—	—	
	Orange	SRD+	7	—	—	—	
	Green	SRD-	8	—	—	—	
	Purple	BAT+	14	—	—	—	
	Gray	BAT-	15	—	—	—	
	Red	VCC	16	—	—	—	
	Black	VCC	17	—	—	—	
	Blue	BKR-	20	—	—	—	
	Yellow	BKR+	21	—	—	—	
	—	—	22	—	—	—	

The shield is clamped to the hood. Braided ground & shield wire.